

SCIROCCO LED INSTALLATIONS MANUAL

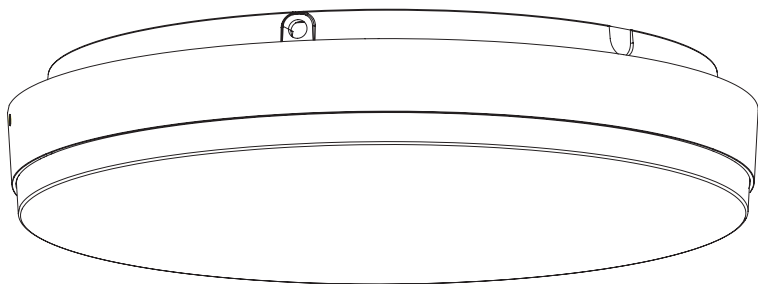

solar | light

STANDARD

Safety Instructions

To ensure correct function and safety, please read and follow all instructions carefully before using the product:

1. Turn off power supply before installation or before doing any maintenance work.
2. Do not install any luminaire near the heat source.
3. IP grade please refer to product label, only IP65 can be used in damp locations.
4. Do not exceed the nominal supply voltage or amperage ratings.
5. All wiring and installation of the light fitting must adhere to local and national wiring rules.
6. Take care not to pull any electrical wires during unpacking as this may damage the connection.
7. Lay out all the components on a smooth surface and make sure there are no components missing before assembling.
8. To avoid injury or damage to the fitting, please ensure that power leads and screws are secure before connecting the power.
9. Please keep instructions for future reference.

Installation Procedure

WARNING

1. Switch off before installation.
2. Switch on only after complete installation and examination of the circuit.
3. Professional electrician for installation and maintenance only.

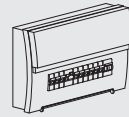

**Turn Off
Power Supply**

Turn Off power supply before starting any installation. Read instructions & check you have all the tools & accessories to complete the installation correctly.

Step 1

Take out ceiling light and accessory pack from box.

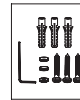
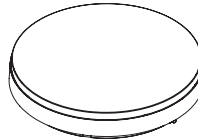

Step 2

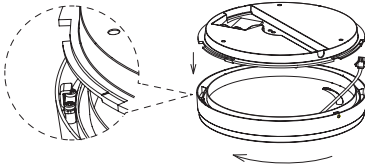

Take the lamp cover apart by rotating it in anti-clockwise direction.

Step 3

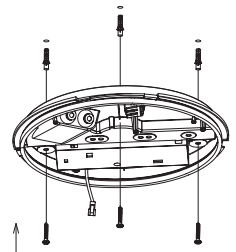

Knock-in the plastic anchor into ceiling, fix the base.

Step 4

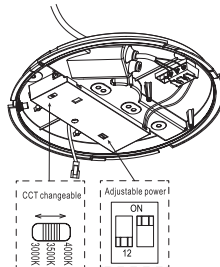

Feed the AC wire into terminal block respectively; If with 3CCT or changeable power function, choose preferred CCT or wattage by slide switch.

Standard	Emergency	Sensor
L = BROWN N = BLUE	L' = UNSWITCHED L = BROWN N = BLUE	L = BROWN N = BLUE
3-CCT	DALI	0-10V
L = BROWN N = BLUE	L = BROWN N = BLUE DALI+ DALI-	L = BROWN N = BLUE 0-10V+ 0-10V-

Step 5

Plug the male and female connector.

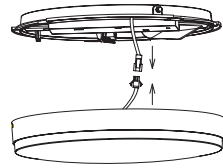

Step 6

Align the hooks on the lamp cover with the notch of the base, rotate the lamp cover clockwise until they match well.

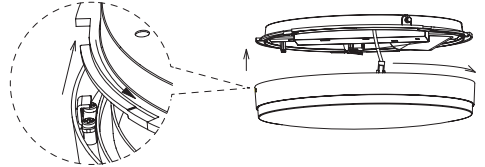

Step 7

Lock the anti-theft screws on the side of the lamp body.

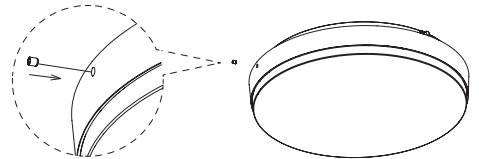

Step 8

Installation finished, turn on the switch.

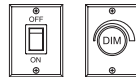

Functions Instruction (For specific function, please refer to actual model)



Emergency

Emergency function switches automatically between power cut and power restoration.

- Li battery, high efficiency
- Battery duration: 3 hours
- Charge period: 24 hours



Sensor

Detection area: 140 degree wide detectable beam angle with 2-10 meters distance.

SENSOR INFORMATION

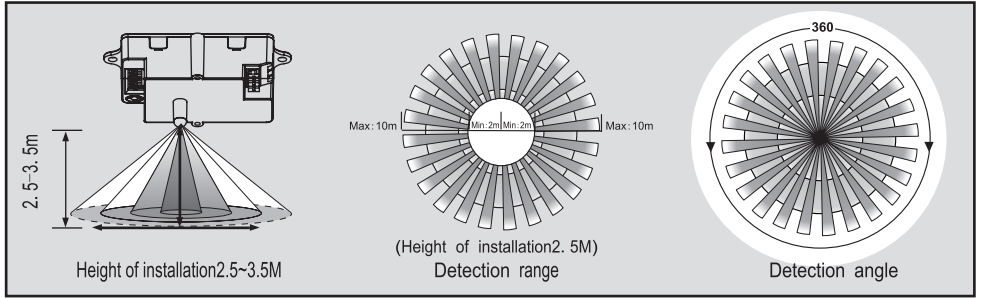

※ Optimum installation height: 3M

Working Pattern (3 different patterns)

Microwave sensor

- In any given lighting condition, the light switches on automatically when presence detected.
- After presence left, light will continuously work within HOLD TIME, then switch off automatically.
- After presence left, any movement detected within HOLD TIME, the light will continuously work for another hold time, then switch off until next movement detected.
- Hold time: Please refer to "HOLD TIME" on product label.

Daylight & Microwave sensor

- With sufficient natural light, when illuminance is more than 10lux, the light does not switch on when presence detected.
- With insufficient natural light:
 - > When illuminance is less than 10lux, the light switches on automatically when presence detected.
 - > With presence detected, light will never switch off, even the nature light is sufficient.
 - > After presence left, any movement detected within HOLD TIME, the light will continuously work for another HOLD TIME, then switch off automatically until next movement detected.
- Hold time: Please refer to "HOLD TIME" on product label.

Default setting

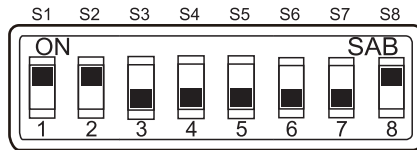
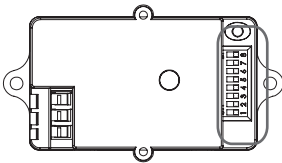

SENS:10M TIME:10S LUX:10lux

Detection range setting (sensitivity)



SENS:S1, S2

S1	S2	Detection range
0	0	2M
0	1	5M
1	0	8M
1	1	10M

Detection range is the term used to describe the radii of the more or less circular detection zone produced on the ground after mounting the sensor light at a height of 2.5m, pull switch to the ON position as "1", pull switch to the OFF position as "0", switch location and detection range of the corresponding table as follows:

Note: the above detection range is gained if the detected person is between 1.6m~1.7m tall with middle figure and moves at a speed of 1.0~1.5m/sec. if person's stature, figure and moving speed change, the detection distance will also change.

ATTENTION: When use this product, please adjust the sensitivity to an appropriate position you need, please do not adjust the sensitivity to maximum, in case the product works abnormally because of wrong motion detection, including blowing leaves & curtains small animals, or even power grid & electrical equipment. All the above factors can lead to abnormal work. When the product does not work normally, please try to lower the sensitivity appropriately, and then test it.

Time setting

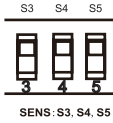

S3	S4	S5	TIME
0	0	0	10s
0	0	1	1min
0	1	0	5min
0	1	1	10min
1	0	0	15min
1	0	1	20min
1	1	0	25min
1	1	1	30min

The light can be set to stay ON for any period of time between approx. 10sec and a maximum of 30min. Any movement detected before this time elapse will re-start the timer. It is recommended to select the shortest time for adjusting the detection zone and for performing the walk test.

Pull switch to the ON position as "1", pull switch to the OFF position as "0", switch location and detection range of the corresponding table is as follows:

NOTE: after the light switches OFF, it takes approx. 4sec before it is able to start detecting movement again. The light will only switch on in response to movement once this period has elapsed.

Light-control setting

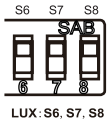

S6	S7	S8	LUX
0	0	0	24H
0	0	1	10LUX
0	1	0	20LUX
0	1	1	50LUX
1	0	0	100LUX
1	0	1	200LUX
1	1	0	300LUX
1	1	1	500LUX

The chosen light response threshold can be infinitely from approx. 10-500lux, pull switch to the ON position as "1", pull switch to the OFF position as "0", switch location and light-control of the corresponding table is as follows:

Hold time "A" please refer to "TIME SETTING" table

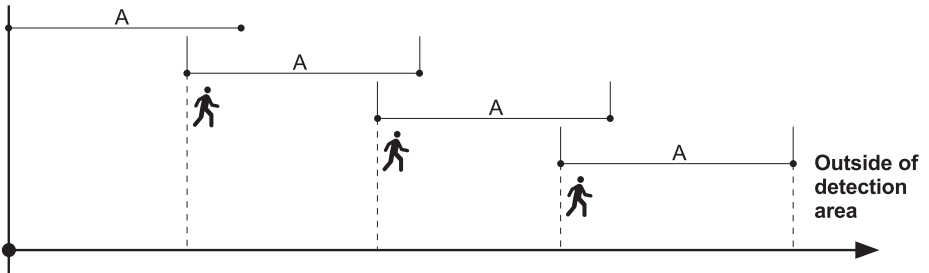

Wiring Diagram:

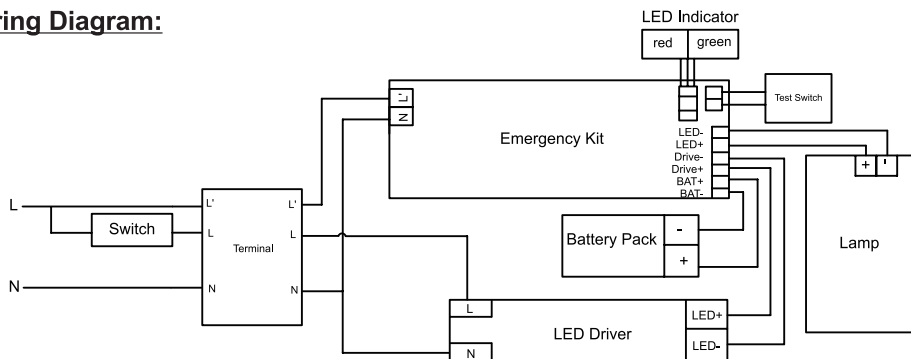

Dali Dimming Connection

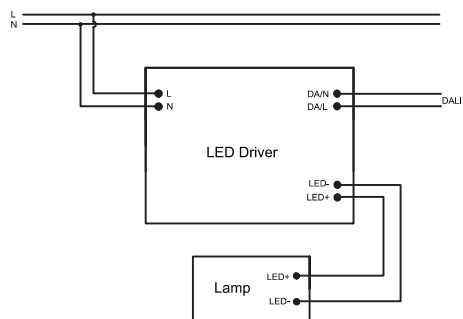

Push Dimming Connection

